

THANKS FOR PURCHASING OUR PRODUCT

# Digi-TIG320ACDC PULS

DC INVERTER  
AC TIG/DC TIG  
DC MMA  
WELDING MACHINE

## OPERATION INSTRUCTIONS

(BE SUITABLE FOR 3x380/400/415V)

10. FOLLOW ALL MANUFACTURER'S RULES on operating switches and making adjustments.
11. ALWAYS WEAR PROTECTIVE CLOTHING when welding. This includes: long sleeves, protective apron without pockets, long protective pants and boots. When handling hot materials, wear asbestos gloves.
12. ALWAYS WEAR A WELDER'S HELMET WITH PROTECTIVE EYE PIECE when welding. Also may cause blindness. Wear a protective cap underneath the helmet.
13. WHEN WELDING OVERHEAD, BEWARE OF HOT METAL DROPPING. Always protect the head, hand, feet and body.
14. KEEP A FIRE EXTINGUISHER CLOSE BY AT ALL TIMES.
15. DO NOT EXCEED THE DUTY CYCLE OF THE MACHINE. The rated cycle of a welding machine is the percentage of a ten minute period that the machine can operate safely at a given output setting.
16. KEEP ALL CHILDREN AWAY FROM WORK AREA. When storing equipment, make sure it is out of reach of children.
17. GUARD AGAINST ELECTRIC SHOCK. DO NOT WORK WHEN WET. Do not let body come in contact with grounded surfaces.

# SAFETY PRECAUTIONS

**Follow these precautions carefully. Improper use of any welder can result in injury or death.**

1. ONLY CONNECT WELDER TO A POWER SOURCE FOR WHICH IT WAS DESIGNED. The specification plate on the welder lists this information. When welding outdoors only use an extension cord intended for such use.
2. ONLY OPERATE WELDER IN DRY LOCATIONS and on cement or masonry floor. Keep area clean and uncluttered.
3. KEEP ALL COMBUSTIBLES AWAY FROM WORK SITE.
4. DO NOT WEAR CLOTHING THAT HAS BEEN CONTAMINATED with grease or oil.
5. KEEP CABLES DRY AND FREE FROM OIL AND GREASE and never coil around shoulders.
6. SECURE WORK WITH CLAMPS or other means; don't overreach when working.
7. NEVER STRIKE AN ARC ON A COMPRESSED GAS CYLINDER
8. DON'T ALLOW THE INSULATED PORTION OF THE ELECTRODE HOLDER TO TOUCH THE WELDING GROUND WHILE CURRENT IS FLOWING.
9. SHUT OFF POWER AND UNPLUG MACHINE WHEN REPAIRING OR ADJUSTING. Inspect before every use. Only use identical replacement parts.
10. FOLLOW ALL MANUFACTURER'S RULES on operating switches and making adjustments.
11. ALWAYS WEAR PROTECTIVE CLOTHING when welding. This includes: long sleeved shirt(leather sleeves), protective apron without pockets, long protective pants and boots. When handling hot materials, wear asbestos gloves.
12. ALWAYS WEAR A WELDER'S HELMET WITH PROTECTIVE EYE PIECE when welding. Arcs may cause blindness. Wear a protective cap underneath the helmet.
13. WHEN WELDING OVERHEAD, BEWARE OF HOT METAL DROPPINGS. Always protect the head, hand, feet and body.
14. KEEP A FIRE EXTINGUISHER CLOSE BY AT ALL TIMES.
15. DO NOT EXCEED THE DUTY CYCLE OF THE MACHINE. The rated cycle of a welding machine is the percentage of a ten minute period that the machine can operate safely at a given output setting.
16. KEEP ALL CHILDREN AWAY FROM WORK AREA. When storing equipment, make sure it is out of reach of children.
17. GUARD AGAINST ELECTRIC SHOCK. DO not work when tired. Do not let body come in contact with grounded surfaces.



## I. MAIN USAGE AND THE RANGE OF USAGE

Digi-TIG320ACDC PULS Welder is triple functional machine used as DC MMA , AC TIG, DC/ PULSE TIG Welder. All ferrous metals copper, Aluminium ,titanium and stainless steel material can be omnibearing welding in all position.The welding current is stable and stepless adjustable.The welding seam is nice. few spatter and low noise occurs during welding.The welder is small volume,light in weight and easy to move.It is particularly suitable for enterprise of pressure vessel,building,shipping and petrochemical works. It is the priority product to replace the NSA series welding machine.

## II. MAIN TECHNICAL SPECIFICATIONS

MODEL		Digi-TIG320ACDC PULS
INPUT	Voltage	3xAC380/400/415V 50/60Hz
DC MMA	No-load Voltage	70V
	current Adjusting Range	20~250A
	Rated Output Current	250A
	Rated Duty Cycle	35%
AC TIG	No-load Voltage	70V
	Current Adjusting Range	10~320A
	SP % (AC balance)	10~70
	AC Square Wave Frequency	30~250Hz
	Rated Duty Cycle	35%
DC TIG	Current Adjusting Range	5~320A
	Rated Duty Cycle	35%
Standard PULSE TIG	Peak Current	5~320A
	Base/peak Current ratio	5~95%
	Rated Duty Cycle	35%
	Pulse width	5%~95%
	pulse Freq.	0.1~500Hz@DC 0.1~250Hz@AC ADV.SQUARE 0.1~10Hz@AC SOFT.SQUARE&TRIANGULAR&SINE WAVE
Advanced PULSE TIG (MIX)	AC peak Current	10~320A
	DC(base)/AC peak Current Ratio	5~95%
	Rated Duty Cycle	35%
	Pulse width	5%~95%
	pulse (AC to DC-) Freq.	0.1~10Hz
Current UP/Down-slope Time		0~10S
Initial current/weldingcurrent		5~150%
crater-fill current/welding current		5~95%
Pre gas Flow Time		0~25s
Post gas Flow Time		0~25s
Arc starting Mode		HF/LIFT TIG
Efficiency		≥80%
Mass		28kg
Protection Class of enclosure		IP21S
Outline Dimensions mm <sup>3</sup>		430x200x290

### III. OPERATING CONDITION AND WORK SURROUNDING

#### 1. Operating condition:

Voltage of power source: 3xAC380V。

Frequency: 50/60Hz

Reliable grounding protection

#### 2. Work surrounding

- ①. relative humidity: not more than 90 %( average monthly temperature not more than 20°C)
- ②. ambient temperature:-10°C ~ 40°C
- ③. The welding site should have no harmful gas, Chemicals, molds and inflammable matter, explosive and corrosive medium, no big vibration and bump to the welder.
- ④. Avoiding rain water. Operating in rain is not allowed.

### IV. DESCRIPTION OF THE ERECTION

#### 1. Before welding, the operator should read the operation instructions.

2. Check the welder appearance for deformation and damage.
3. For the safety of the equipment and the persons, the customer must correctly make grounding or protection according to the power supply system: using 4mm<sup>2</sup> lead to connect the protection grounding of the welder
4. Welding operation should be carried out in dry and good ventilating area. The surrounding objects should be not less than 0.5m away from the welder.
5. Checking the welder output connector for tightness.
6. The welder can not be moved and the cover can not be opened during the power is on and welding operation is carried out.
7. The welder should be cared, used and managed by specialized person.
8. Current of the distribution board: not less than 40A

### V. SKETCH SKETCH THE PANEL FUNCTION

1. FRONT PANEL

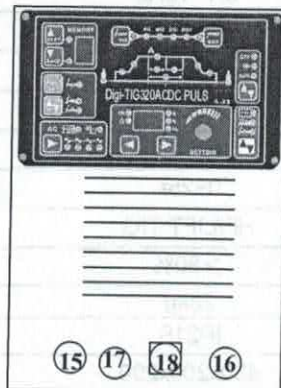

2. BACK PANEL

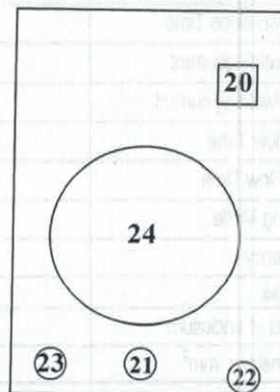



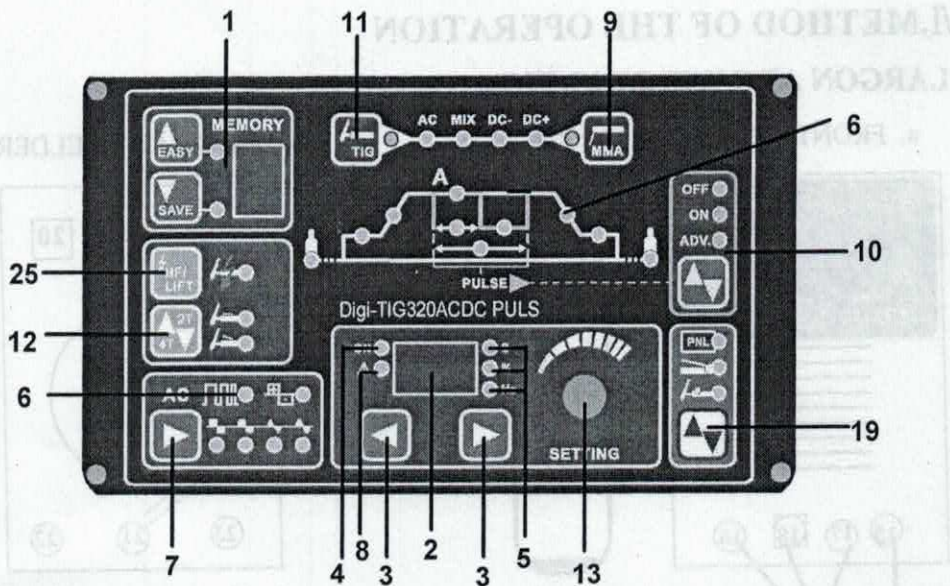

- 1.Memory chanel LED
2. Data Display meter
3. Parameter Select function
- 4.indicating light of power
5. S -- unit of up & downslope time & pre& post flow time  
% -- unit of AC balance & peak time on  
Hz-- unit of pulse freq.&AC freq.
6. indicating light of Parameter Select function ( Pre-flow /Start current/Up slope/Welding Amps ( Pulse peak amps) /peak time on/ pulse freq./base Amps/down slope/end current/post flow/AC freq./ AC balance)
- 7.AC selector  
AC WAVE FORM: advanced square/soft square/triangular square / sine square
- 8.warning indicating light
9. MMA selector  
DC-/DC+
- 10.TIG PULSE selector
- 11.TIG selector  
DC TIG/AC TIG/MIX TIG
12. 2 T/ 4 T selector
13. Data Display Adjustment Knob
15. output"+" (Welding holder)
16. output"-" ( Ground clamp)
- 17.argon out
- 18.argon arc control (or remote control)
- 19.Amp Adjustment selector (remote control)  
panel/ pedal /finger torch
20. power switch
- 21.argon inlet
- 22.power supply
- 23.safety earthing column
- 24.fan
- 25.HF/Lift TIG selector

## VI. METHOD OF THE OPERATION

### 1. ARGON ARC WELDING (TIG)

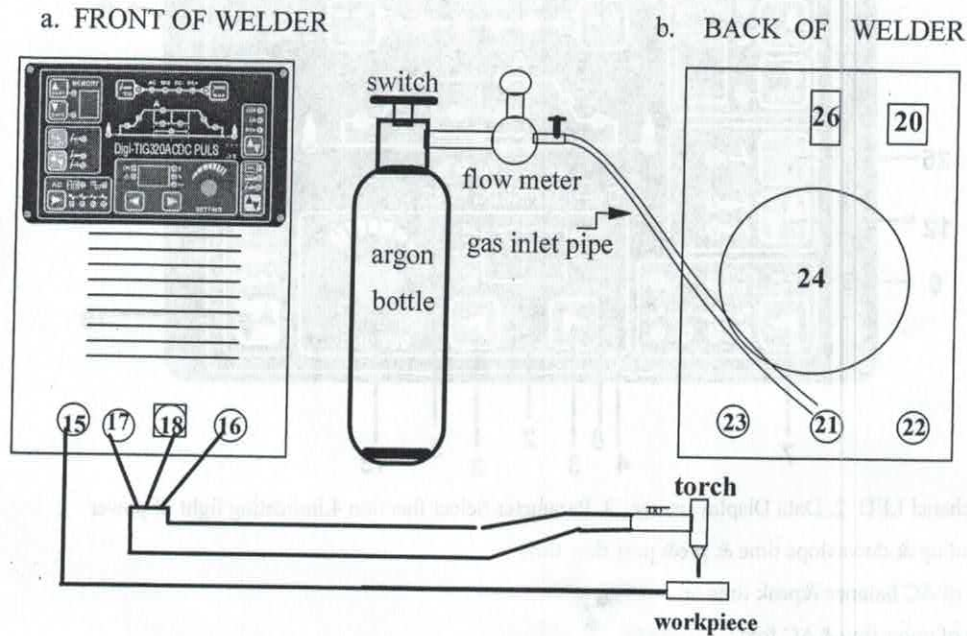

#### 1.1 CLEARING BEFORE WELDING

Tungsten argon arc welding is very sensitive to surface contamination of filled metal. Therefore before welding is carried out, grease, paint and coating on the surface, lubricant for machining and oxidized film should be removed.

#### 1.2 DC ARGON ARC WELDING

①. selector "11" onto the position " DC TIG "or "AC TIG" or "MIX TIG", selector "10" onto the position " pulse off " ,Connecting the gas inlet pipe to inlet "21" of the welding.

②. Connecting gas inlet pipe of the welding torch to argon output of welder "17".

③. Putting the aerial plug of the welding torch in the argon arc control socket "18".

④. Testing gas: get the power of the welder ready and switch on the power "2", open the argon bottle switch and switch on the flow meter, press the torch switch, select suitable argon flow.

⑤. .Regulating the knob " 3 & 13". Selecting suitable welding current according to thickness of the workpiece to be welded.. Selecting suitable current down slope time and post flow time according to the current.

**Notice 1:** The current indicating meter on the front panel is used to display the preset output current level before welding, and actual output level while welding: A lit display indicates input power is turned on.

**Notice 2:** When using 'Adjustable foot control'.regulating the current with sole. selector "12" onto the position " PEDAL "welding current will increase gradually when you step at full tilt the 'Adjustable foot control' with sole.

**Notice 3:** When using 'Adjustable finger control torch'.regulating the current with finger. selector "19" onto the position " Panel " or " PEDAL "or "finger torch",,, then begin to weld.



⑥. Tungsten electrode end is 2-3mm away from the welding workpiece. Press the torch switch, arc striking will occur.

**Notice:** During welding, when the " 12. 2T/4Tswitch"on "2T", switch of the torch must be pressed and can not be released.otherwise the arc will be broken.

⑦.Releasing the switch of the torch, welding current will reduce gradually (time is adjustable) and arc extinguishes.The welding torch can not be removed as soon as the arc extinguishing. Let the protection gas cooling down for the welding seam not to be oxidized.

⑧.When the welding operation is finished, turn off argon bottle switch and cut off input power of the welder.

### 1.3 PULSE ARGON ARC WELDING

- ①. Selection of peak current and base current:
- ②. selector "11" onto the position " DC TIG " or "AC TIG "and selector "10" onto the position " on",
- ③.select peak time on ratio: It can be selected between 5%-95%.
- ④.select up-slope&down slope time: It can be selected between 0-10S.
- ⑤.Gas connecting and testing,are generating and are blowing off etc. are all the same as DC are welding.

### 1.4 PULSE ARGON TUNGSTEN WEIDING PROCESS (only for reference)

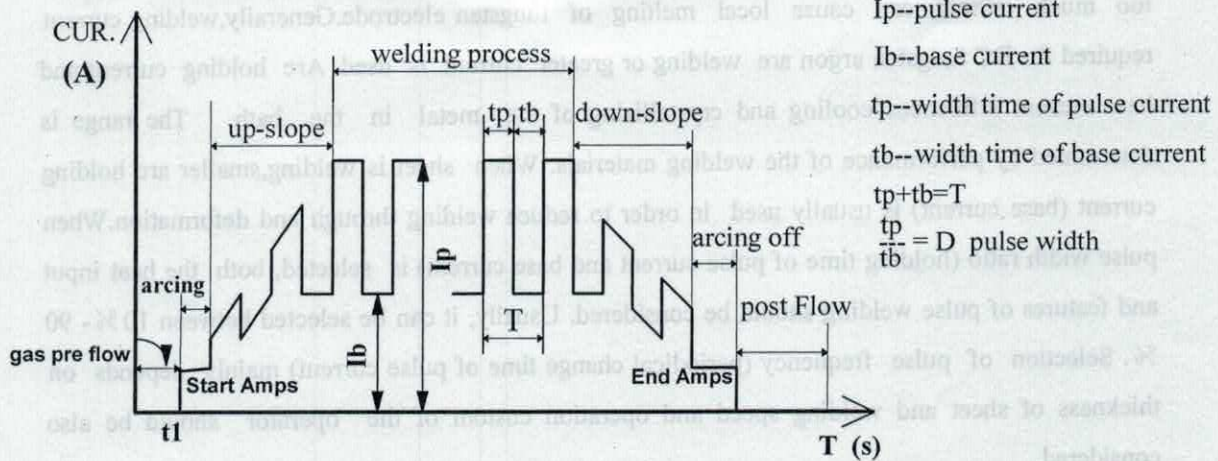

①.Features and application scope of the process .

The pulse type argon tungsten are welding is different from the continuous(DC) argon are welding.The welding current is pulsed.The wave form of the current is shown in the following sketch.Ip and Ib and their continuous time tp and tb can be regulated according to requirements of the process. The amplitude value of electric current changes periodically with certain frequency in case of the pulse current, molten base will be formed in the workpiece and the molten bath will be solidified in care of base current.The welding seam is formed by reciprocal overlaps. Welding heat input can be controlled by regulating pulse frequency, pulse current amplitude, size of base current,continuous time of pulse current and base current and therefore the welding seam,size and quality of the zone influenced from heat can be controlled.

②.Advantages and application scope of pulse argon gas tungsten arc welding

a. Precisely control the size of the bath inputting heat to workpiece to increase penetration

resistance of molten seam and preservation of bath. It is easy to obtain even fusing deepness. This process is specially applicable to omni-bearing welding of sheet and formation to be done with both sides through one side welding.

b. Heating and cooling of each welding point is very fast. Therefore, the process is applicable for the workpiece with great difference of heat conductivity and thickness.

c. Pulse arc can obtain greater fusing deepness with lower heat input. Therefore under the same condition, the zone influenced from welding heat and deformation from welding can be reduced. This is very important for sheet and ultra-thin sheet welding.

d. Fast cooling of the bath metal and shot duration time of high temperature during welding can reduce cracks caused to the thermo-sensitive materials during welding.

### ③. Selection of welding parameters

Except for pulse current and the width time (width ratio) as well as pulse frequency, welding parameters of pulse argon gas tungsten arc welding are as same as general tungsten DC argon arc welding. Pulse current increasing means electric arc can obtain greater penetration ability. But too much current can cause local melting of tungsten electrode. Generally, welding current required for DC tungsten argon arc welding or greater current is used. Arc holding current and base current influences cooling and crystallizing of the metal in the bath. The range is determined by performance of the welding materials. When sheet is welding, smaller arc holding current (base current) is usually used in order to reduce welding through and deformation. When pulse width ratio (holding time of pulse current and base current) is selected, both the heat input and features of pulse welding should be considered. Usually, it can be selected between 10% - 90%. Selection of pulse frequency (periodical change time of pulse current) mainly depends on thickness of sheet and welding speed and operation custom of the operator should be also considered.

## 1.4 AC ARGON ARC WELDING

1. selector "11" onto the position "AC TIG", selector "25" onto the position "HF TIG", selector "10" onto the position "off" or "Advanced AC", Connecting the gas inlet pipe to inlet "21" of the welding.

2. The method of the connection same as 1.1

3. select right "sp(AC Balance)"

$$SP = \frac{t_p}{t_n} * 100\%$$

$t_p$ : the time of  $I_2$  at positive       $t_n$ : the time of  $I_n$  at Negative

4. select right AC square wave frequency & AC balance.



5. The Method of the welding same as 1.1

## 2. Hand welding with electrode

- ①. selector "9" onto the position "DC+" or "DC-"
- ②. select right welding current

select empiric formula:  $I=40d$ ,  $d$  is dia. of the electrode.

- ③. Notice positive and negative connection during welding.

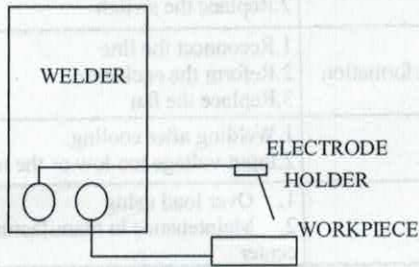

- ④. Connecting input power for the welder, then switch on the power and current indicating light "4" is on.
- ⑤. Pay attention to rated welding current and rated duty cycle of the welder. Overload is not allowed.
- ⑥. After the welding operation is finished, let the welder be ventilated for a few minutes and then cut off the power switch.

## VII. SYSTEMATIC BLOCK DIAGRAM

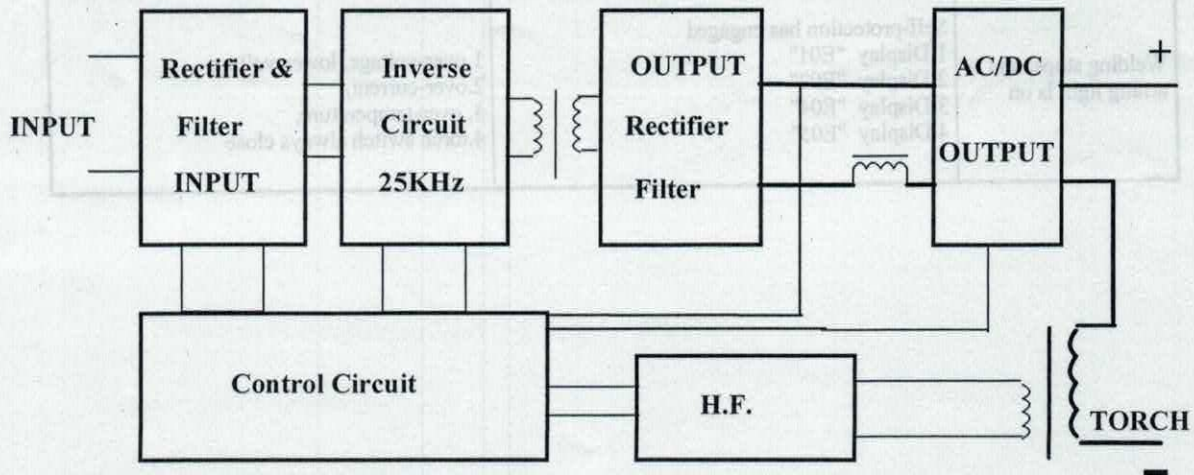

VIII. This product is sold subject to the understanding that if any defect in manufacture or material shall appear within 12 months from date of consumer sale, the manufacturer will arrange for such defect to be rectified without charge on the sales invoice and warranty card (except for any personal trouble).

**General Troubles and Problem Solving:**

Trouble	Causes	Problem Solving
Power lamp not light	1.No electricity input 2.Switch of welder fails.	1.Check incoming line 2.Replace the switch
Fan not rotating	1.Fan power line is off. 2.Enclosure blocks the fan due to deformation 3.The fan fails.	1.Reconnect the line 2.Reform the enclosure 3.Replace the fan
Warning lamp lights	1.Over heat(yellow lamp lights) 2.Over current(Green lamp lights)	1.Welding after cooling. 2.Input voltage too low or the machine fails.
No output of welder	1.Over current protection 2. Welder fails	1. Over load using 2. Maintenance in manufacturer or service center
Output current decreased	1. Input Voltage is low 2. Input line is too thin	2. Power line is thickened
Current can not be regulated	1.Connecting line of the potentiometer is off 2.Potentiometer for current regulation fail	1.Reconnecting the line 2.Replace potentiometer
High frequency arc can not be generated	1.The switch fails 2.Interval of high frequency discharging is too big 3.Distance of the torch and workpiece is too far high frequency arc generator fails	1.Replace torch switch 2.Regulating discharging interval to 0.8-1.0mm 3.Put torch tungsten electrode close to workpiece 4.Replace high frequency arc generator
Arc of argon welding is broken or tungsten electrode is burnt	1.Argon gas flow is not regulated well 2.Tungsten electrode fails 3.Value of current does not match with dia. of tungsten electrode 4.After flow time too short	1.Regulated well 2.Replace or sharpen 3.Select the electrode dia. and current correctly 4.Enlarge the time
Welding torch overheat	1.Not use the water cooling when the current is more than 160A 2.The argon flow is the low current	1.Use water cooling 2.Enlarge the argon flow
Welding stops, and warning light is on	Self-protection has engaged 1.Display "E01" 2.Display "E02" 3.Display "E04" 4.Display "E05"	1. over-voltage, lower-voltage 2. over-current, 3. over-temperature, 4. torch switch always close



			
<b>WARNING</b>	<ul style="list-style-type: none"> <li>Do not touch electrically live parts or electrode with skin or wet clothing.</li> <li>Insulate yourself from work and ground.</li> </ul>	<ul style="list-style-type: none"> <li>Keep flammable materials away.</li> </ul>	<ul style="list-style-type: none"> <li>Wear eye, ear and body protection.</li> </ul>
Spanish <b>AVISO DE PRECAUCION</b>	<ul style="list-style-type: none"> <li>No toque las partes o los electrodos bajo carga con la piel o ropa mojada.</li> <li>Aíselese del trabajo y de la tierra.</li> </ul>	<ul style="list-style-type: none"> <li>Mantenga el material combustible fuera del área de trabajo.</li> </ul>	<ul style="list-style-type: none"> <li>Protéjase los ojos, los oídos y el cuerpo.</li> </ul>
French <b>ATTENTION</b>	<ul style="list-style-type: none"> <li>Ne laissez ni la peau ni des vêtements mouillés entrer en contact avec des pièces sous tension.</li> <li>Isolez-vous du travail et de la terre.</li> </ul>	<ul style="list-style-type: none"> <li>Gardez à l'écart de tout matériel inflammable.</li> </ul>	<ul style="list-style-type: none"> <li>Protégez vos yeux, vos oreilles et votre corps.</li> </ul>
German <b>WARNUNG</b>	<ul style="list-style-type: none"> <li>Berühren Sie keine stromführenden Teile oder Elektroden mit Ihrem Körper oder feuchter Kleidung!</li> <li>Isolieren Sie sich von den Elektroden und dem Erdboden!</li> </ul>	<ul style="list-style-type: none"> <li>Entfernen Sie brennbares Material!</li> </ul>	<ul style="list-style-type: none"> <li>Tragen Sie Augen-, Ohren- und Körperschutz!</li> </ul>
Portuguese <b>ATENÇÃO</b>	<ul style="list-style-type: none"> <li>Não toque partes elétricas e electrodos com a pele ou roupa molhada.</li> <li>Isole-se da peça e terra.</li> </ul>	<ul style="list-style-type: none"> <li>Mantenha inflamáveis bem guardados.</li> </ul>	<ul style="list-style-type: none"> <li>Use proteção para a vista, ouvido e corpo.</li> </ul>
Japanese <b>注意事項</b>	<ul style="list-style-type: none"> <li>通電中の電気部品、又は溶材にヒブやぬれた布で触れないこと。</li> <li>施工物やアースから身体が絶縁されている様にして下さい。</li> </ul>	<ul style="list-style-type: none"> <li>燃えやすいものの側での溶接作業は絶対にしてはなりません。</li> </ul>	<ul style="list-style-type: none"> <li>目、耳及び身体に保護具をして下さい。</li> </ul>
Chinese <b>警告</b>	<ul style="list-style-type: none"> <li>皮肤或湿衣物切勿接触带电部件及焊缝。</li> <li>使你自已与地面和工件绝缘。</li> </ul>	<ul style="list-style-type: none"> <li>把一切易燃物品移离工作场所。</li> </ul>	<ul style="list-style-type: none"> <li>佩戴眼、耳及身体劳动保护用具。</li> </ul>
Korean <b>위험</b>	<ul style="list-style-type: none"> <li>전도체나 용접봉을 젖은 행갑 또는 피부로 절대 접촉치 마십시오.</li> <li>모재와 접지를 접촉치 마십시오.</li> </ul>	<ul style="list-style-type: none"> <li>인화성 물질을 접근 시키지 마십시오.</li> </ul>	<ul style="list-style-type: none"> <li>눈, 귀와 몸에 보호장구를 착용하십시오.</li> </ul>
Arabic <b>تحذير</b>	<ul style="list-style-type: none"> <li>لا تلمس الأجزاء التي يسري فيها التيار الكهربائي أو الألكترود بجلة الجسم أو بالمعالبس المبللة بالماء.</li> <li>ضع عازلا على جسمك خلال العمل.</li> </ul>	<ul style="list-style-type: none"> <li>ضع المواد القابلة للاشتعال في مكان بعيد.</li> </ul>	<ul style="list-style-type: none"> <li>ضع أدوات ومعالبس واقية على عينيك وأذنيك وجسمك.</li> </ul>

READ AND UNDERSTAND THE MANUFACTURER'S INSTRUCTION FOR THIS EQUIPMENT AND THE CONSUMABLES TO BE USED AND FOLLOW YOUR EMPLOYER'S SAFETY PRACTICES.

SE RECOMIENDA LEER Y ENTENDER LAS INSTRUCCIONES DEL FABRICANTE PARA EL USO DE ESTE EQUIPO Y LOS CONSUMIBLES QUE VA A UTILIZAR, SIGA LAS MEDIDAS DE SEGURIDAD DE SU SUPERVISOR.

LISEZ ET COMPRENEZ LES INSTRUCTIONS DU FABRICANT EN CE QUI REGARDE CET EQUIPMENT ET LES PRODUITS A ETRE EMPLOYES ET SUIVEZ LES PROCEDURES DE SECURITE DE VOTRE EMPLOYEUR.

LESEN SIE UND BEFOLGEN SIE DIE BETRIEBSANLEITUNG DER ANLAGE UND DEN ELEKTRODENEINSATZ DES HERSTELLERS. DIE UNFALLVERHÜTUNGSVORSCHRIFTEN DES ARBEITGEBERS SIND EBENFALLS ZU BEACHTEN.

			
<ul style="list-style-type: none"> <li>● Keep your head out of fumes.</li> <li>● Use ventilation or exhaust to remove fumes from breathing zone.</li> </ul>	<ul style="list-style-type: none"> <li>● Turn power off before servicing.</li> </ul>	<ul style="list-style-type: none"> <li>● Do not operate with panel open or guards off.</li> </ul>	<b>WARNING</b>
<ul style="list-style-type: none"> <li>● Los humos fuera de la zona de respiración.</li> <li>● Mantenga la cabeza fuera de los humos. Utilice ventilación o aspiración para gases.</li> </ul>	<ul style="list-style-type: none"> <li>● Desconectar el cable de alimentación de poder de la máquina antes de iniciar cualquier servicio.</li> </ul>	<ul style="list-style-type: none"> <li>● No operar con panel abierto o guardas quitadas.</li> </ul>	Spanish <b>AVISO DE PRECAUCION</b>
<ul style="list-style-type: none"> <li>● Gardez la tête à l'écart des fumées.</li> <li>● Utilisez un ventilateur ou un aspirateur pour ôter les fumées des zones de travail.</li> </ul>	<ul style="list-style-type: none"> <li>● Débranchez le courant avant l'entretien.</li> </ul>	<ul style="list-style-type: none"> <li>● N'opérez pas avec les panneaux ouverts ou avec les dispositifs de protection enlevés.</li> </ul>	French <b>ATTENTION</b>
<ul style="list-style-type: none"> <li>● Vermeiden Sie das Einatmen von Schweißrauch!</li> <li>● Sorgen Sie für gute Be- und Entlüftung des Arbeitsplatzes!</li> </ul>	<ul style="list-style-type: none"> <li>● Strom vor Wartungsarbeiten abschalten! (Netzstrom völlig öffnen; Maschine anhalten!)</li> </ul>	<ul style="list-style-type: none"> <li>● Anlage nie ohne Schutzgehäuse oder Innenschutzverkleidung in Betrieb setzen!</li> </ul>	German <b>WARNUNG</b>
<ul style="list-style-type: none"> <li>● Mantenha seu rosto da fumaça.</li> <li>● Use ventilação e exaustão para remover fumo da zona respiratória.</li> </ul>	<ul style="list-style-type: none"> <li>● Não opere com as tampas removidas.</li> <li>● Desligue a corrente antes de fazer serviço.</li> <li>● Não toque as partes elétricas nuas.</li> </ul>	<ul style="list-style-type: none"> <li>● Mantenha-se afastado das partes moventes.</li> <li>● Não opere com os painéis abertos ou guardas removidas.</li> </ul>	Portuguese <b>ATENÇÃO</b>
<ul style="list-style-type: none"> <li>● ヒュームから頭を離すようにして下さい。</li> <li>● 換気や排煙に十分留意して下さい。</li> </ul>	<ul style="list-style-type: none"> <li>● メンテナンス・サービスに取りかかる際には、まず電源スイッチを必ず切ってください。</li> </ul>	<ul style="list-style-type: none"> <li>● パネルやカバーを取り外したままで機械操作をしないで下さい。</li> </ul>	Japanese <b>注意事項</b>
<ul style="list-style-type: none"> <li>● 頭部遠離煙霧。</li> <li>● 在呼吸區使用通風或排風器除煙。</li> </ul>	<ul style="list-style-type: none"> <li>● 維修前切斷電源。</li> </ul>	<ul style="list-style-type: none"> <li>● 儀表面板打開或沒有安全罩時不準作業。</li> </ul>	Chinese <b>警告</b>
<ul style="list-style-type: none"> <li>● 얼굴로부터 용접가스를 멀리하십시오.</li> <li>● 호흡지역으로부터 용접가스를 제거하기 위해 가스제거기나 통풍기를 사용하십시오.</li> </ul>	<ul style="list-style-type: none"> <li>● 보수전에 전원을 차단하십시오.</li> </ul>	<ul style="list-style-type: none"> <li>● 패널이 열린 상태로 작동치 마십시오.</li> </ul>	Korean <b>위험</b>
<ul style="list-style-type: none"> <li>● ابعد رأسك بعيداً عن الدخان.</li> <li>● استعمل التهوية أو جهاز ضغط الدخان للخارج لكي تبعد الدخان عن المنطقة التي تنتفس فيها.</li> </ul>	<ul style="list-style-type: none"> <li>● اقطع التيار الكهربائي قبل القيام بأية صيانة.</li> </ul>	<ul style="list-style-type: none"> <li>● لا تشغيل هذا الجهاز إذا كانت الاغطية الحديدية الواقية ليست عليه.</li> </ul>	Arabic <b>تحذير</b>

**LEIA E COMPREENDA AS INSTRUÇÕES DO FABRICANTE PARA ESTE EQUIPAMENTO E AS PARTES DE USO, E SIGA AS PRÁTICAS DE SEGURANÇA DO EMPREGADOR.**

使う機械や資材のメーカーの指示書をよく読み、まず理解して下さい。そして貴社の安全規定に従って下さい。

請詳細閱讀並理解製造廠提供的說明以及應該使用的銀焊材料，並請遵守貴方的有關勞動保護規定。

이 제품에 동봉된 작업지침서를 숙지하시고 귀사의 작업자 안전수칙을 준수하시기 바랍니다.

اقرأ بتمعن وافهم تعليمات المصنع المنتج لهذه المعدات والمواد قبل استعمالها واتبع تعليمات الوقاية لصاحب العمل.



**IX .ACCESSORIES:SEE PACKING LIST,PLEASE**

**PACKING LIST**

model	quantity	remark	note
Digi-TIG320ACDC PULS Welding machine	1		PACKING 1
Welding Holder	1		PACKING 1
Ground clamp	1		PACKING 1
TIG welding torch	1		PACKING 1
Adjustable foot control	1	optional accessory	
Adjustable finger control torch	1	optional accessory	
gas inlet pipe	1		PACKING 1
Operation instructions	1		PACKING 1
Certificate of quality	1		PACKING 1



No. \_\_\_\_\_

**Certificate of quality**

Name of product: AC/DC/PULSE TIG WELDING

Type of product: Digi-TIG320ACDC PULS

Packing No: 152107532

Test results of this welder fulfils \_\_\_\_\_

\_\_\_\_\_ technical requirements and its release

from the works is granted.

Inspector INSPI Date 07 26 2021



PACKING LIST  
 B. JACOBSEN ESSEL FACTORY LTD. LEAS

QTY	DESCRIPTION	UNIT	REMARKS
1	COILS OF PIPE		
1	OPERATION INSTRUCTIONS		
1	CONTROL PANEL		
1	ADJUSTABLE RIG - CONTROL PANEL		
1	EXHAUSTIVE FLOW CONTROL		
1	TWO WELDER TROL		
1	GRINDING CLAMP		
1	WELDING TROUBLE		
1	WELDING MACHINE		
1	TOP-TROUBLE WELDER		

\*\*\*\*\*

No.

Certificate of quality

Name of producer: ESSEL FACTORY LTD. LEAS

Type of product: TOP-TROUBLE WELDER

Lotting No: 152107532

Test results of this welder: \_\_\_\_\_

Technical requirements and its values: \_\_\_\_\_

from the work is granted: \_\_\_\_\_

Inspected by: [Signature]

07 28

2021



No. 1018

h. 1. 1. 6